

NA4901-2RSR-XL

Needle roller bearing

Schaeffler ID:
0507751540000

Needle roller bearings NA49..-2RSR,
dimension series 49, lip seals on both
sides

X-life

Technical information

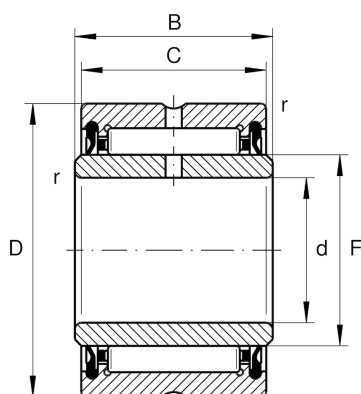

Main Dimensions & Performance Data

d	12 mm	Bore diameter
D	24 mm	Outside diameter
B	14 mm	Width, inner ring
C_r	8,600 N	Basic dynamic load rating, radial
C_{0r}	8,300 N	Basic static load rating, radial
C_{ur}	1,660 N	Fatigue load limit, radial
$n_{G \text{ Grease}}$	13,900 1/min	Limiting speed for grease lubrication
	27.3 g	Weight

Dimensions

F	16 mm	Raceway diameter inner ring
C	13 mm	Width, outer ring
r_{\min}	0.3 mm	Minimum chamfer dimension

Temperature range

T_{\min}	-20 °C	Operating temperature min.
T_{\max}	100 °C	Operating temperature max.